

# ACCESSORIES AND SPARE PARTS FOR OCTOPUS GRIPPING SYSTEMS AND BARS

## Digital vacuum switch with 1/8" gas axial connection

Item	Description
12 10 10	Digital vacuum switch



## Electrical cable with axial connector

Item	Description
00 12 20	Electrical connection cable with axial connector for digital vacuum switch length 5 m



## Electrical cable with radial connector

Item	Description
00 12 21	Electrical connection cable with radial connector for digital vacuum switch length 5 m

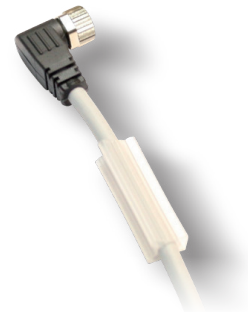

## Vacuum gauge Ø 40 mm with 1/8" coaxial gas coupler

Item	Description
09 03 15	Vacuum gauge



## Pressure gauge Ø 40 mm with 1/8" coaxial gas coupler

Item	Description
09 03 25	Pressure gauge



Silencer

Item	For generator item
SSX 1/4"	PVP 25 MX PO - PVP 25 MX PBO



Sealing kit and reed valves

Item	For generator item
00 KIT PVP 25 MX	PVP 25 MX PO - PVP 25 MX PBO

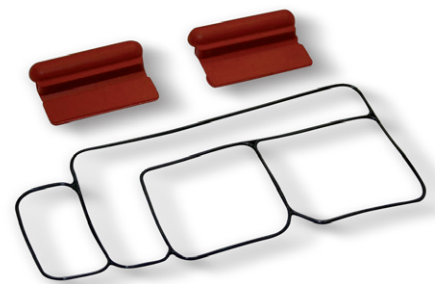

Item	For generator item
00 KIT PVP 100 M	PVP 100 M PO
00 KIT PVP 140 M	PVP 140 M PO
00 KIT PVP 170 M	PVP 170 M PO
00 KIT PVP 200 M	PVP 200 M PO

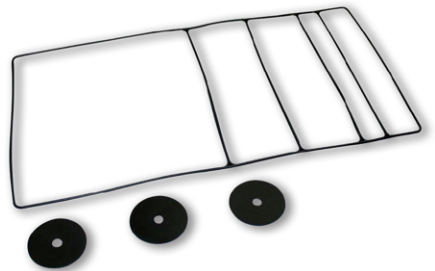

Item	For generator item
00 KIT PVP 150 MD	PVP 150 MD PO
00 KIT PVP 300 MD	PVP 300 MD PO
00 KIT PVP 450 MD	PVP 450 MD PO

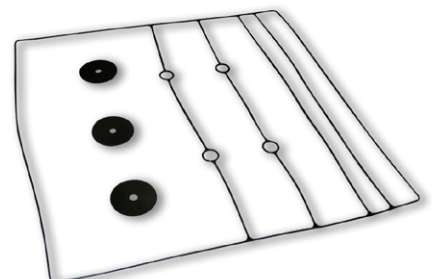

# ACCESSORIES AND SPARE PARTS FOR OCTOPUS GRIPPING SYSTEMS AND BARS

## Stainless steel disc filters

Item	D	For OCTOPUS systems
00 SO 05	25	SO 15 20 - BO 08 60 - BO 08 80 - BO 08 100 - BO 08 120 BO 12 40 - BO 12 60 - BO 12 80 - BO 12 100 - BO 12 120 - BO 12 140
00 SO 10	50	SO 20 30 - SO 20 40 - SO 20 60 - SO DO 35
00 SO 14	80	SO 30 30 - SO 30 40 - SO 30 50 - SO 40 40 SO 40 60 - SO DO 50 - SO 40 100 - SO 60 80 SO 60 120 - SO 80 100

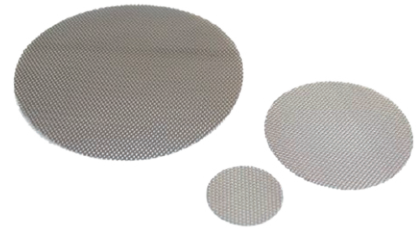

## Supports for vacuum cups with calibrated hole

Item	D ∅	Weight g	Support material	For vacuum cup item
00 08 157	1.5	4	aluminium	01 18 29
00 08 178	2.5	4	aluminium	01 18 29

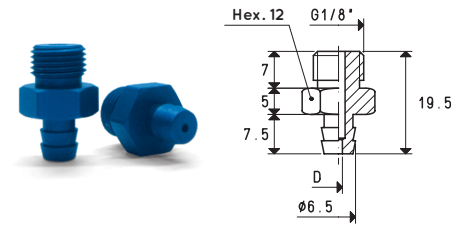

Item	D ∅	Weight g	Support material	For vacuum cup item
00 08 158	1.5	8	aluminium	01 40 42
00 08 425	5	8	aluminium	01 40 42

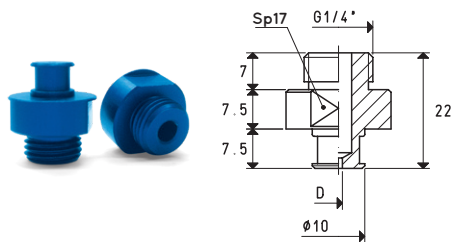

Item	Weight g	Support material	For vacuum cup item
00 08 170	4	aluminium	01 20 23

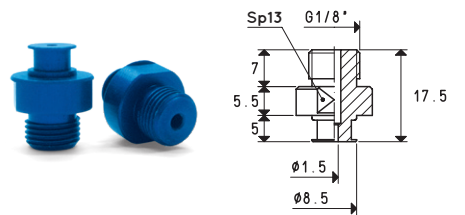

## Shut-off valves

Item	A ∅	B ∅	d ∅	D ∅	E	H	Ch	Weight g	Support material
14 01 06	G1/4"	G1/8"	3.25	15	18	28	12	10	aluminium

Minimum trigger flow = 1.5 m³/h

Minimum level of vacuum = -250 mbar

Item	A ∅	B ∅	d ∅	D ∅	E	H	Ch	Weight g	Support material
14 01 07	G3/8"	G1/4"	4.50	20	25	35	17	24	aluminium

Minimum trigger flow = 4 m³/h

Minimum level of vacuum = -250 mbar

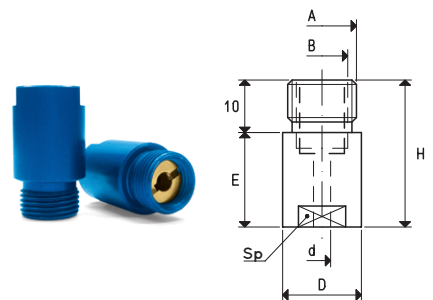

Transformation ratio: N (newton) = Kg x 9.81 (force of gravity)

inch =  $\frac{\text{mm}}{25.4}$ ; pounds =  $\frac{\text{g}}{453.6} = \frac{\text{Kg}}{0.4536}$